

WATER FEATURES

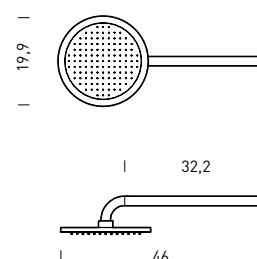
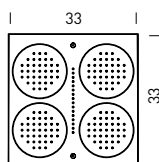
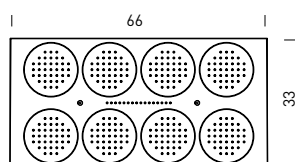
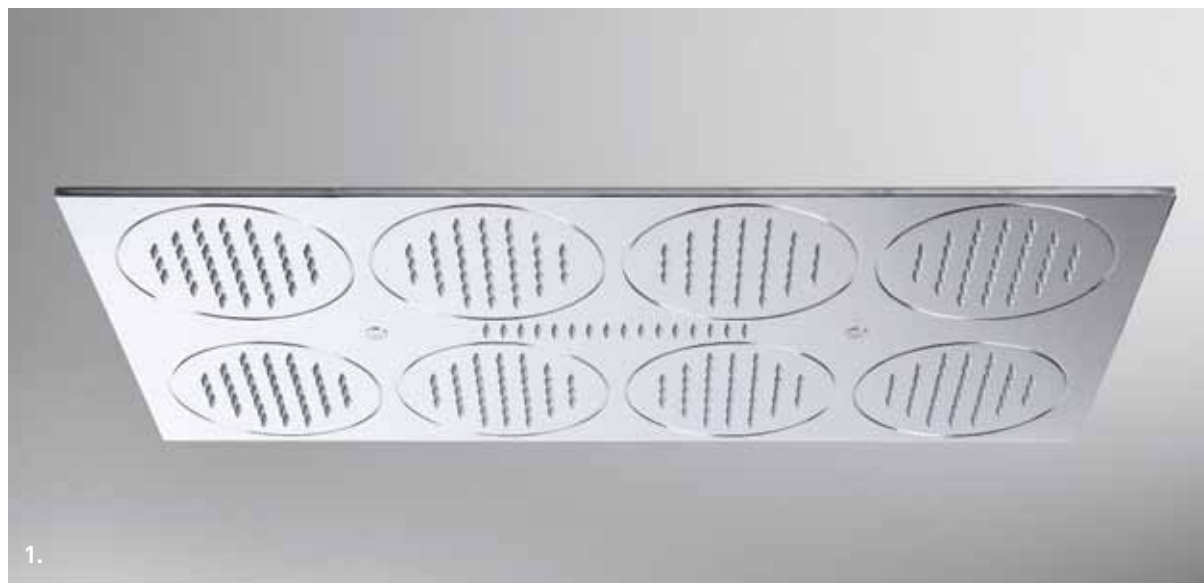

1. RA32----

RECTANGULAR CENTRAL SHOWER HEAD

330x660 mm inset into the false ceiling or ceiling-mounted, dual rain spray and concentrated massage function, 296+16 anti-lime scale nozzles, chromed brass body, double 1/2" fitting. Efficient massage even with a 10 l/minute flow rate.

2. RA33----

SQUARE CENTRAL SHOWER HEAD

330x330 mm inset into the false ceiling or ceiling-mounted, dual rain spray and concentrated massage function, 148+16 anti-lime scale nozzles, chromed brass body, double 1/2" fitting. Efficient massage even with a 10 l/minute flow rate.

3. RA31----

WALL-MOUNTED CENTRAL SHOWER HEAD

for wall fastening, 200 mm in diameter, 350 mm rod, 121 anti-lime scale nozzles, chromed brass body, washer, 1/2" wall fitting.

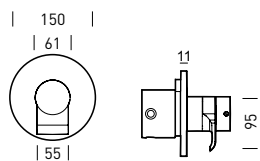

4. RA10----
**THERMOSTATIC MIXER
 WITH BUILT-IN STOP COCK**
 thermostatic mixer with inset
 built-in flow regulator,
 150mm diameter cover plate,
 3/4" fittings. High flow rate
 even with low water pressures.

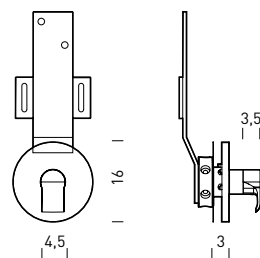

**5. RA12----, RA13----,
 RA14----, RA15----**
FLOW DIVERTER
 inset 2-5 way, 160 mm
 diameter cover plate,
 1/2" fittings.

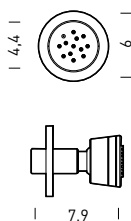

6. RA21----
WALL JET
 massage jet for wall
 mounting with anti-lime
 scale system, joint,
 washer, 1/2" fitting.
 Efficient massage even
 with a 2 l/minute flow rate.

WATER FEATURES

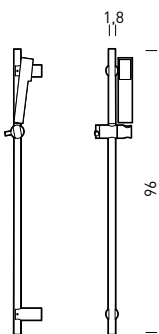

7. RA22----
LIGHT SHOWER RAIL
 shower unit with riser rail,
 sliding rail support, shower
 with anti-lime scale system,
 900 mm in length, 1500 mm long
 hose, washer, 1/2" wall fitting.

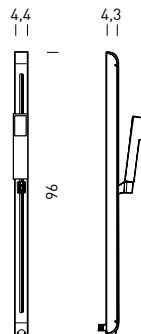

8. RA23----
SHOWER RAIL ON TRACK
 shower unit with riser track,
 anti-lime scale shower system,
 960 mm in length, 1500 mm
 long flexible hose,
 chromed brass and steel finishes,
 built-in 1/2" wall fitting.



9.



10.



11.

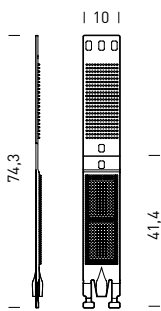

9. RA24----
MASSAGING STRIP
for wall mounting,
washer, 1/2" fitting.

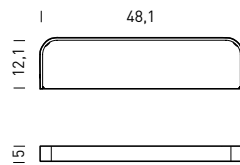

10. K040----
ACCESSORY SHELF
480 mm width, 120 mm
width, chromed brass
and steel finishes.

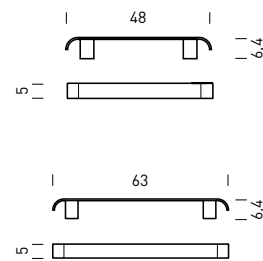

11. K041----, K042----
TOWEL RAIL,
630 or 480 mm length,
chromed brass body.

LEAF
ANGELETTI RUZZA DESIGN



RL26

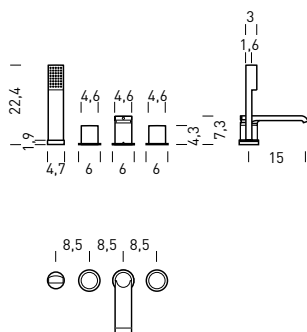

RL25
TUB LEDGE ASSEMBLY 4 HOLES
WITH HAND SHOWER:

- 175 MM DEEP
- SPOUT HEIGHT: 73 MM
- SIDE TAPS WITH 3/4" CERAMIC DISK TAPS
- AUTOMATIC BATH/SHOWER FLOW DIVERTER
- "NO DROP SYSTEM" HAND SHOWER
- SHOWER OUTLET WITH NON-RETURN VALVE

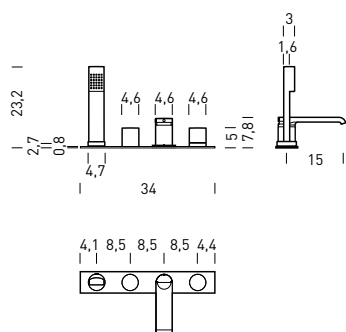

RL26
TUB LEDGE ASSEMBLY 4 HOLES WITH
HAND SHOWER AND FINISHING PLATE:

- 175 MM DEEP
- SPOUT HEIGHT: 73 MM
- SIDE TAPS WITH 3/4" CERAMIC DISK TAPS
- AUTOMATIC BATH/SHOWER FLOW DIVERTER
- "NO DROP SYSTEM" HAND SHOWER
- SHOWER OUTLET WITH NON-RETURN VALVE
- FINISHING PLATE

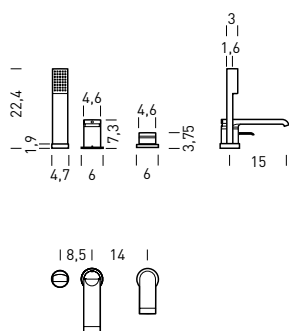

RL27
TUB LEDGE ASSEMBLY SINGLE LEVER
MIXER TAP WITH HAND SHOWER:

- 175 MM DEEP
- SPOUT HEIGHT: 73 MM
- SINGLE LEVER MIXER TAP CARTRIDGE Ø 38 MM
- AUTOMATIC BATH/SHOWER FLOW DIVERTER
- "NO DROP SYSTEM" HAND SHOWER
- SHOWER OUTLET WITH NON-RETURN VALVE

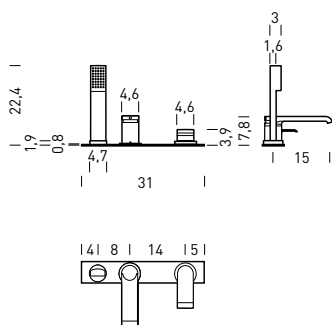

RL28
TUB LEDGE ASSEMBLY SINGLE LEVER MIXER TAP
WITH HAND SHOWER AND FINISHING PLATE:

- 175 MM DEEP
- SPOUT HEIGHT: 73 MM
- SINGLE LEVER MIXER TAP CARTRIDGE Ø 38 MM
- AUTOMATIC BATH/SHOWER FLOW DIVERTER
- "NO DROP SYSTEM" HAND SHOWER
- SHOWER OUTLET WITH NON-RETURN VALVE
- FINISHING PLATE

LEAF



RL21



RL22



RL23

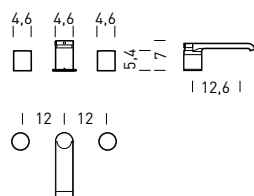

RL24

**RL21****THREE HOLE WASH BASIN TAP SET:**

- 150 MM DEEP
- SPOUT HEIGHT: 70 MM
- SIDE TAPS WITH 3/4" CERAMIC DISK TAPS
- 1 1/4" DRAIN TRAP
- 2 M 10X1 PRESSURE HOSES

RL22**SINGLE HOLE WASH BASIN TAP SET:**

- 150 MM DEEP
- SPOUT HEIGHT: 70 MM
- 1 1/4" DRAIN TRAP
- SINGLE LEVER MIXER TAP CARTRIDGE Ø32 WITH CERAMIC DISKS
- 2 M 10X1 PRESSURE HOSES, SCREW FITTING

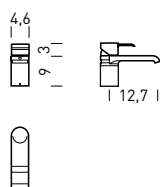
**RL23****THREE HOLE BIDET TAP SET:**

- 150 MM DEEP
- SPOUT HEIGHT: 70 MM
- SIDE TAPS WITH 1/2" CERAMIC DISK TAPS
- 1 1/4" DRAIN TRAP
- M 22X1 AERATOR WITH M 24X1 SWIVEL OUTLET
- 2 M 10X1 PRESSURE HOSES, SCREW FITTING

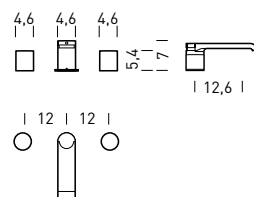
**RL24****SINGLE HOLE BIDET TAP SET:**

- 150 MM DEEP
- SPOUT HEIGHT: 70 MM
- 1 1/4" DRAIN TRAP
- SINGLE LEVER MIXER TAP CARTRIDGE Ø32 WITH CERAMIC DISKS
- M 22X1 AERATOR WITH M 24X1 SWIVEL OUTLET
- 2 M 10X1 PRESSURE HOSES, SCREW FITTING

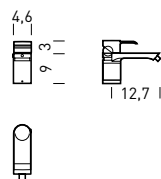



R370



R380
HIGH CAPACITY WATERFALL
WALL-MOUNTED TUB ASSEMBLY:

- WITH SINGLE LEVER MIXER TAP AND AUTOMATIC FLOW DIVERTER
- SPOUT INCORPORATING LIQUID CRYSTAL THERMOMETER AND DIFFUSER
- 1800 MM LONG FLEXIBLE HOSE
- DUAL FUNCTION SHOWER:
 - SPRINKLER
 - MASSAGE JET
- WALL-MOUNTED SHOWER HOLDER



R370
HIGH CAPACITY WATERFALL TUB ASSEMBLY:

- WITH SINGLE LEVER MIXER TAP AND AUTOMATIC FLOW DIVERTER
- SPOUT INCORPORATING LIQUID CRYSTAL THERMOMETER AND DIFFUSER
- LEDGE-MOUNTED SHOWER HOLDER
- 1800 MM LONG FLEXIBLE HOSE
- DUAL FUNCTION SHOWER:
 - SPRINKLER
 - MASSAGE JET
- WALL-MOUNTED SHOWER HOLDER

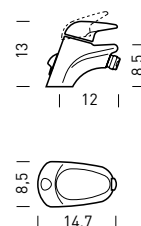
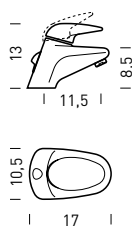
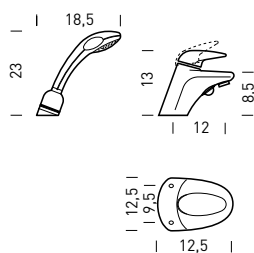

R371

TUB LEDGE ASSEMBLY:

- WITH SINGLE LEVER MIXER TAP AND AUTOMATIC FLOW DIVERTER
- SPOUT INCORPORATING LIQUID CRYSTAL THERMOMETER AND DIFFUSER
- LEDGE-MOUNTED SHOWER HOLDER
- 1800 MM LONG FLEXIBLE HOSE
- DUAL FUNCTION SHOWER:
 - SPRINKLER
 - MASSAGE JET
- WALL-MOUNTED SHOWER HOLDER

R570

WASH BASIN ASSEMBLY:

- WITH SINGLE LEVER MIXER TAP AND AUTOMATIC FLOW DIVERTER
- SPOUT INCORPORATING LIQUID CRYSTAL THERMOMETER AND AERATOR
- 1 1/4" DRAIN TRAP

R670

BIDET ASSEMBLY:

- WITH SINGLE LEVER MIXER TAP
- SPOUT INCORPORATING LIQUID CRYSTAL THERMOMETER
- SWIVEL OUTLET WITH AERATOR
- 1 1/4" DRAIN TRAP